

KLASSIK, ZAOBLENÝ TVAR (ROG)

- Vďaka univerzálnemu formátu 180 x 380 mm sa škridla môže používať na rôznych projektoch.
- Verne zvýrazňuje historický charakter stavieb pri rekonštrukciách historických striech.
- Ideálna aj na moderné architektonické projekty, napríklad ako strešná krytina elegantných rezidencií.
- Má najbohatšiu paletu farieb a škálu povrchov v celej ponuke škridiel značky CREATON.

TECHNICKÉ DÁTA

Veľkosť (cca)	180 x 380 x 14 mm
Krycia šírka max. (cca)	180 mm
Vzdialenosť lát min. (cca)	145 mm
Vzdialenosť lát v počte (cca)	155 mm
Vzdialenosť lát max. (cca)	165 mm
Spotreba škridiel min. (cca)	33.6 ks / m ²
Spotreba škridiel množstvo (cca)	36 ks / m ²
Hmotnosť na kus (cca)	1.8 kg / kus
Hmotnosť na m ² (cca)	64.8 kg / m ²
Hmotnosť na paletu (cca)	927 kg
Minimálne balenie, počet kusov	8 kus
ks/paleta	480 kus

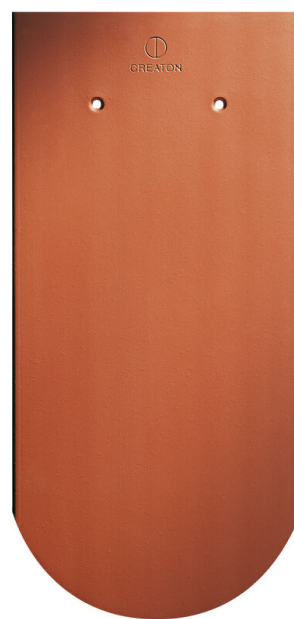

HODNOTY LAF- / FLA

HODNOTY LAF / FLA V MM PRE LATOVANIE 30X50										
Spotreba hrebenáčov (cca)	DN	20°	25°	30°	35°	40°	45°	50°	55°	60°
BG 3.0 ks / m	LAF	90	85	80	80	80	75	75	80	85
BMK 3.0 ks / m	LAF			60	60	55	55	50	50	45
BMZ 2.7 ks / m	LAF	90	85	80	75	75	75	75	80	80
BM 3.0 ks / m	LAF	90	85	80	80	80	75	75	85	85
BZ 3.0 ks / m	LAF	90	85	80	75	75	75	75	80	

HODNOTY LAF / FLA V MM PRE LATOVANIE 40X60										
Spotreba hrebenáčov (cca)	DN	20°	25°	30°	35°	40°	45°	50°	55°	60°
BG 3.0 ks / m	LAF	85	80	75	75	75	65	60	65	70
BMK 3.0 ks / m	LAF			55	55	50	45	35		
BMZ 2.7 ks / m	LAF	85	80	75	70	70	65	60	65	65
BM 3.0 ks / m	LAF	85	80	75	75	75	65	60	70	70
BZ 3.0 ks / m	LAF	85	80	75	70	70	65	60	65	

HODNOTY LAF / FLA V MM PRE LATOVANIE 50X50										
Spotreba hrebenáčov (cca)	DN	20°	25°	30°	35°	40°	45°	50°	55°	60°
BG 3.0 ks / m	LAF	80	75	70	65	65	55	50	55	55
BMK 3.0 ks / m	LAF			50	45	40	35	25		
BMZ 2.7 ks / m	LAF	80	75	70	60	60	55	50	55	50
BM 3.0 ks / m	LAF	80	75	70	65	65	55	50	60	55
BZ 3.0 ks / m	LAF	80	75	70	60	60	55	50	55	



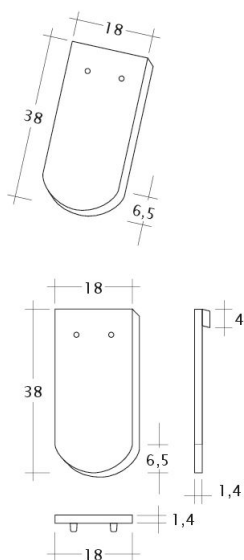

Technický výkres škridla KLASSIK 1-1

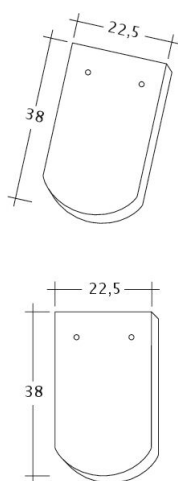

Technický výkres škridla KLASSIK 1-1-4



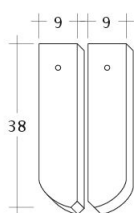
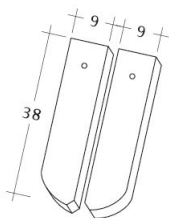

Technický výkres škridla KLASSIK 1-2

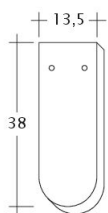
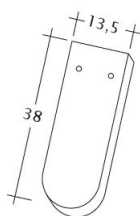

Technický výkres škridla KLASSIK 3-4



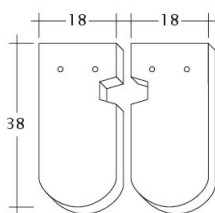
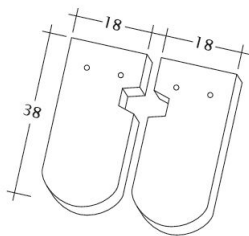

Technický výkres škridla KLASSIK Ausschnitt-LUEFTZ

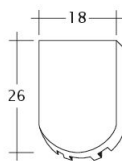
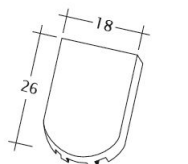

Technický výkres škridla KLASSIK FALZ



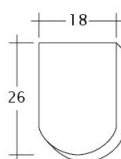
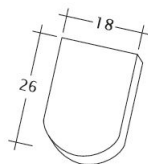

Technický výkres škrídlu KLASSIK Firstanschluss

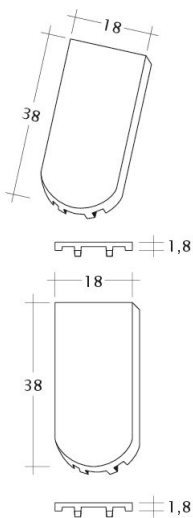

Technický výkres škrídlu KLASSIK Flaechenluefter



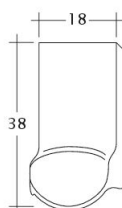
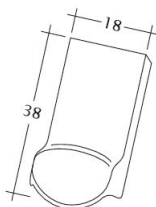

Technický výkres škridla KLASSIK LUEFTZ

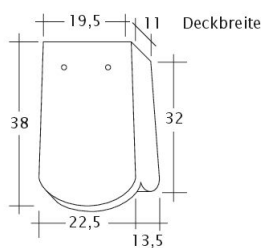
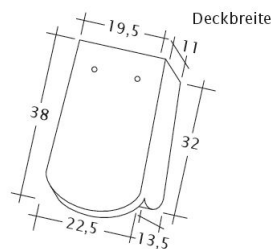

Technický výkres škridla KLASSIK OG-1-1-4



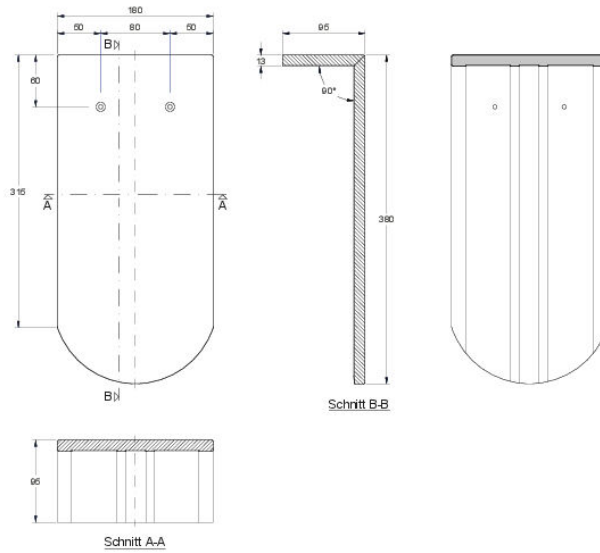

Technický výkres škridla KLASSIK PULT-lang

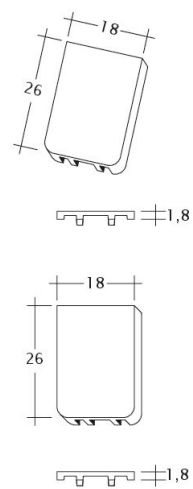

Technický výkres škridla KLASSIK Traufleufter



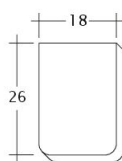
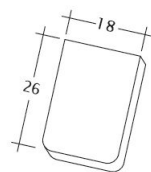

Technický výkres škridly KLASSIK Traufziegel

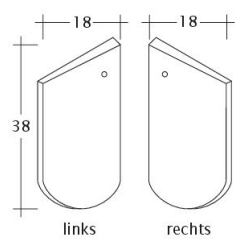
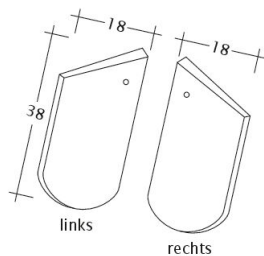

Technický výkres škridly KLASSIK Unterlaeuffer



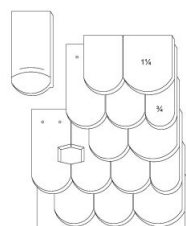

Technický výkres škridla KLASSIK Ortgang-Doppeldeckung-3-4-1-1-4-Traufziegel

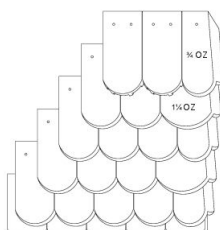

Technický výkres škridla KLASSIK Ortgang-Doppeldeckung-mit-OG-3-4-1-1-4-Traufziegel



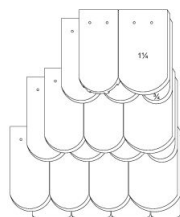

Technický výkres škridla KLASSIK Ortgang-Kronendeckung-3-4-1-1-4-Traufziegel

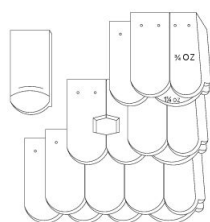

Technický výkres škridla KLASSIK Ortgang-Kronendeckung-mit-OG-3-4-1-1-4



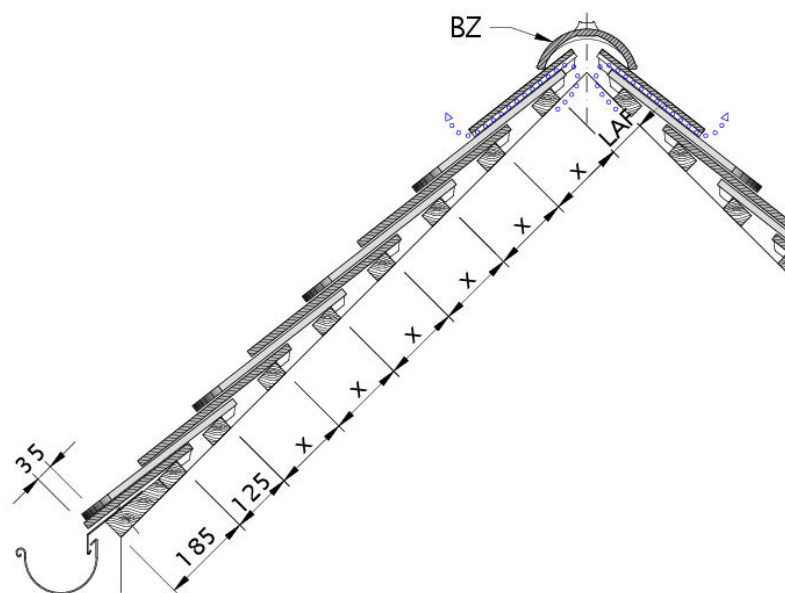

Technický výkres škridla KLASSIK DQF DQD-1

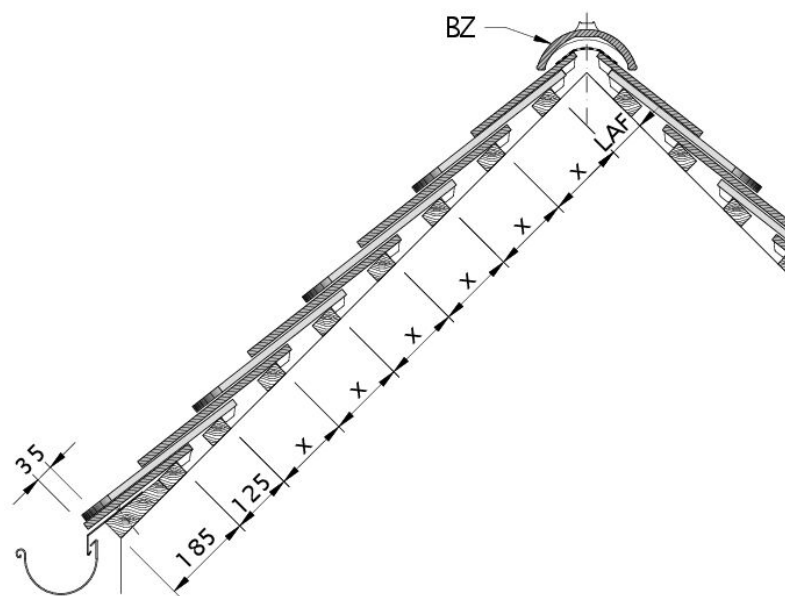

Technický výkres škridla KLASSIK DQF DQD-2



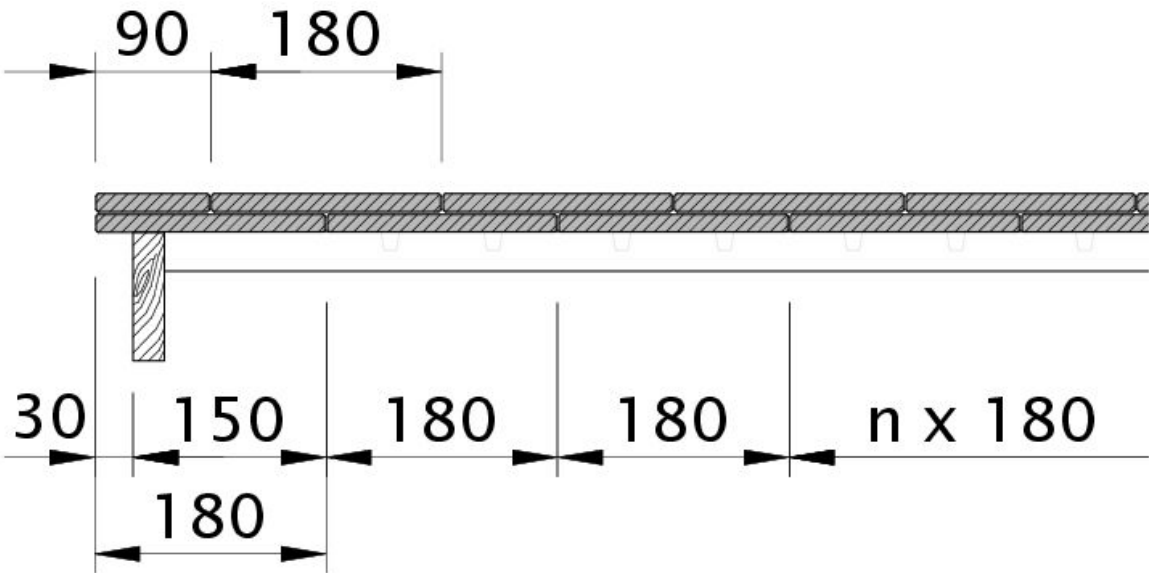

NAMENSKONVENTION#PRO_ZEI_KLA_OBL112 OBL112

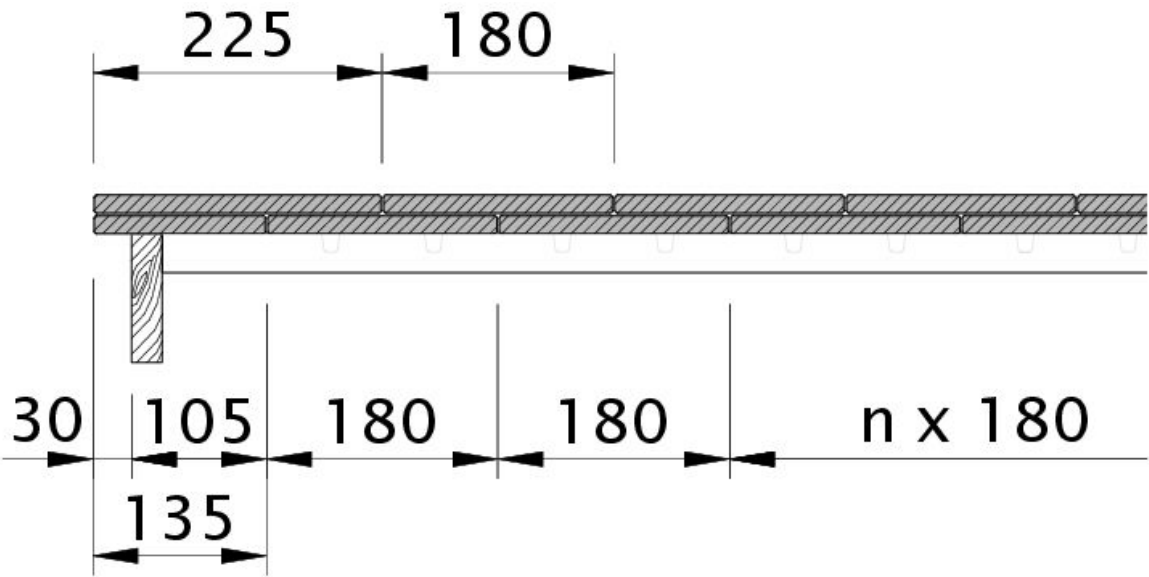

NAMENSKONVENTION#PRO_ZEI_KLA_OBL114 OBL114



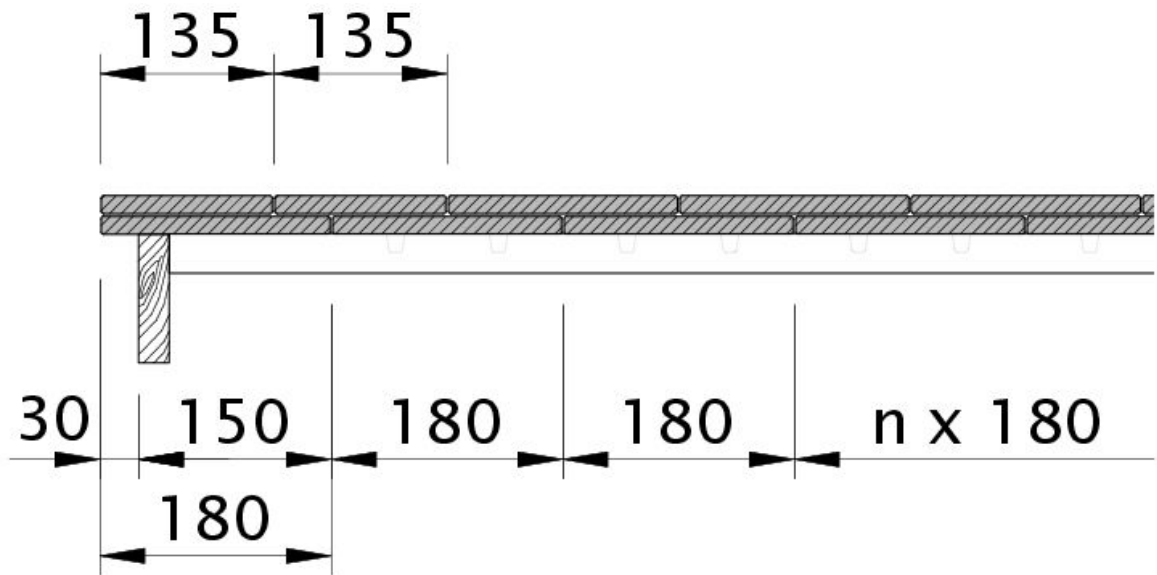

NAMENSKONVENTION#PRO_ZEI_KLA_OBL234 OBL234

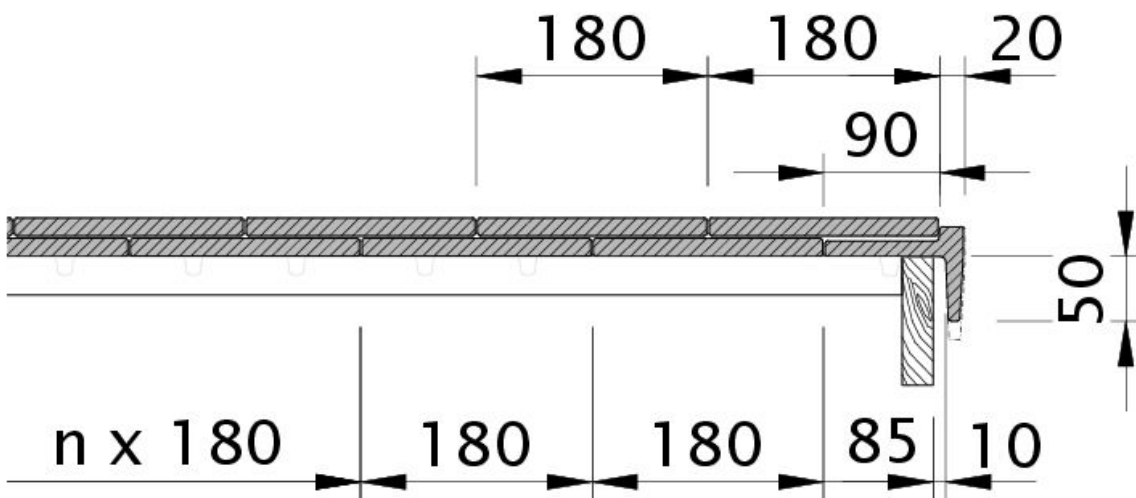

Technický výkres škrídlý KLASSIK OBR OBRSCH



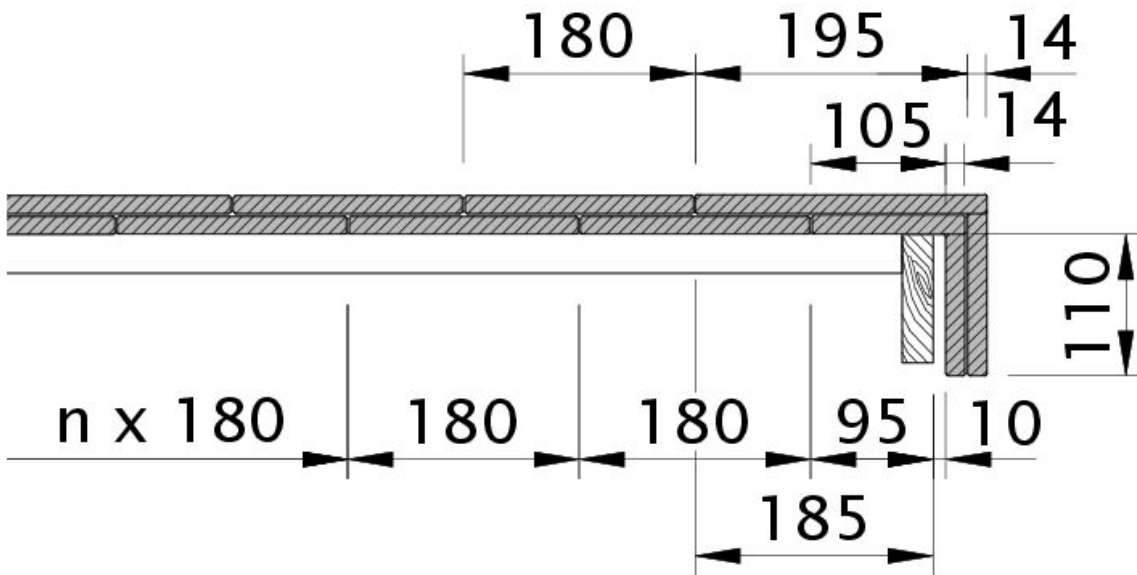

Technický výkres škridla KLASSIK OBR OBR

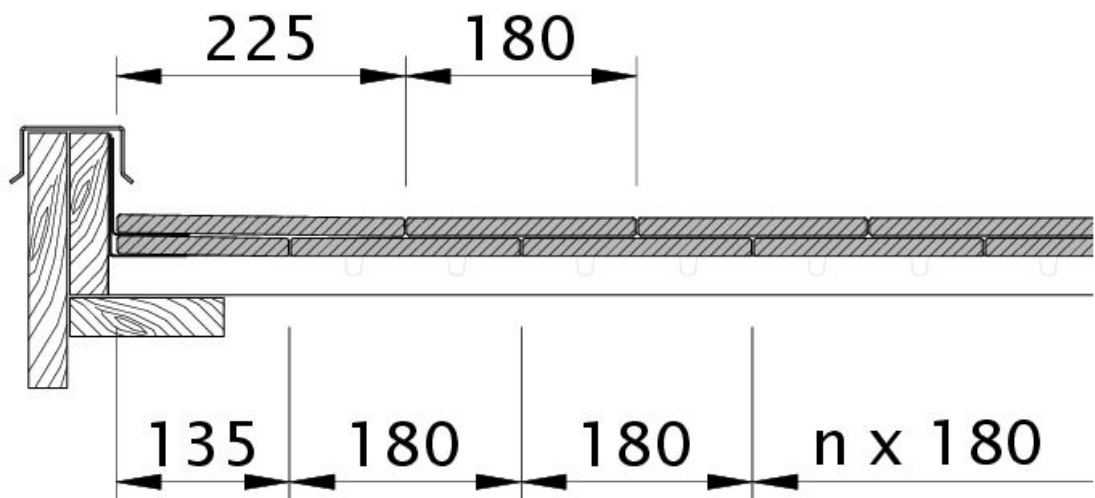

NAMENSKONVENTION#PRO_ZEI_KLA_OGLWA OGLWA



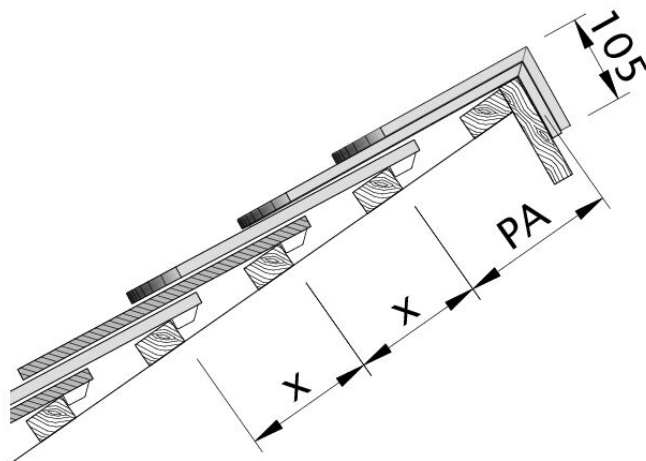

Technický výkres škridla KLASSIK PDA PDA

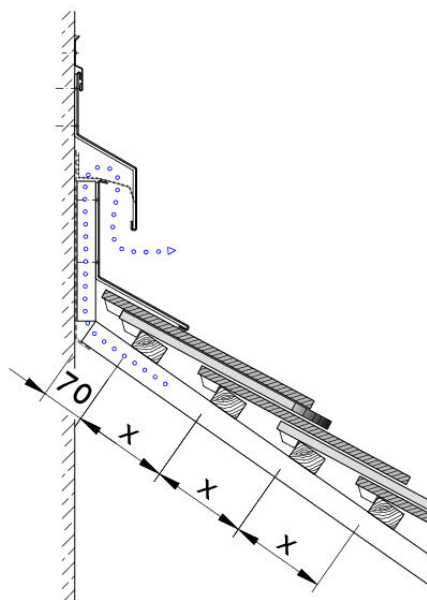

Technický výkres škridla KLASSIK WMF WMF-1



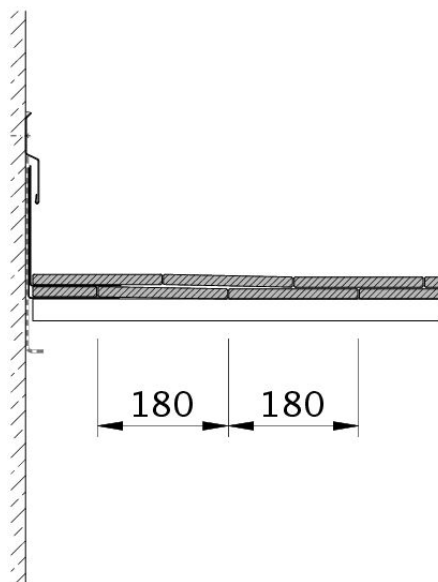

Technický výkres škridla KLASSIK WMF WMF-2

